

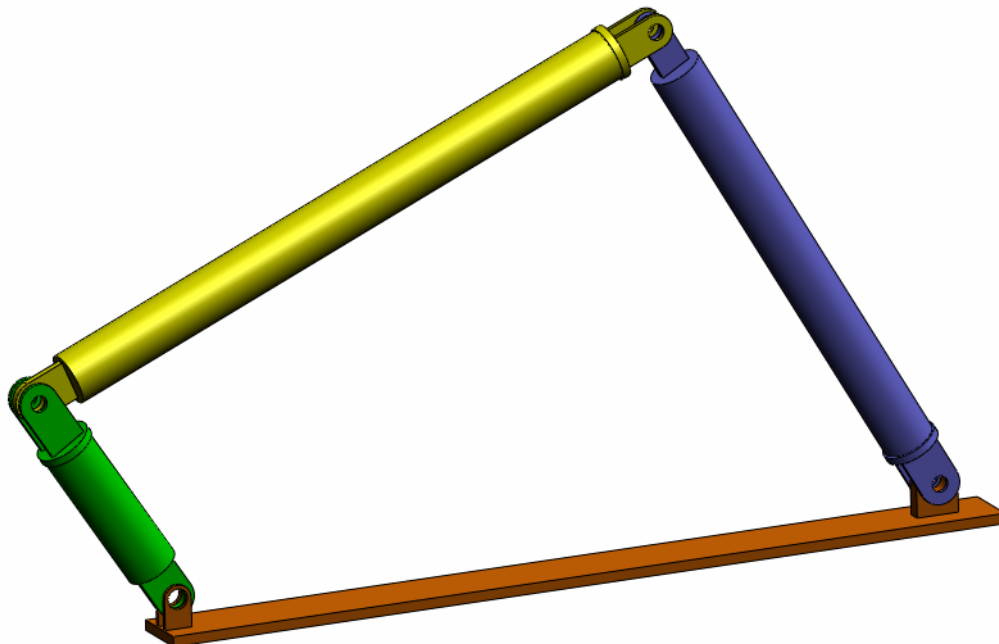

*Engineering Design  
and Technology Series*

# **An Introduction to Motion Analysis Applications with SolidWorks Motion, Instructor Guide**



Dassault Systèmes SolidWorks Corporation  
300 Baker Avenue  
Concord, Massachusetts 01742 USA  
Phone: +1-800-693-9000

Outside the U.S.: +1-978-371-5011  
Fax: +1-978-371-7303  
Email: [info@solidworks.com](mailto:info@solidworks.com)  
Web: <http://www.solidworks.com/education>

© 1995-2010, Dassault Systèmes SolidWorks Corporation, a Dassault Systèmes S.A. company, 300 Baker Avenue, Concord, Mass. 01742 USA. All Rights Reserved.

The information and the software discussed in this document are subject to change without notice and are not commitments by Dassault Systèmes SolidWorks Corporation (DS SolidWorks).

No material may be reproduced or transmitted in any form or by any means, electronically or manually, for any purpose without the express written permission of DS SolidWorks.

The software discussed in this document is furnished under a license and may be used or copied only in accordance with the terms of the license. All warranties given by DS SolidWorks as to the software and documentation are set forth in the license agreement, and nothing stated in, or implied by, this document or its contents shall be considered or deemed a modification or amendment of any terms, including warranties, in the license agreement.

### Patent Notices

SolidWorks® 3D mechanical CAD software is protected by U.S. Patents 5,815,154; 6,219,049; 6,219,055; 6,611,725; 6,844,877; 6,898,560; 6,906,712; 7,079,990; 7,477,262; 7,558,705; 7,571,079; 7,590,497; 7,643,027; 7,672,822; 7,688,318; 7,694,238; 7,853,940; and foreign patents, (e.g., EP 1,116,190 and JP 3,517,643).

eDrawings® software is protected by U.S. Patent 7,184,044; U.S. Patent 7,502,027; and Canadian Patent 2,318,706.

U.S. and foreign patents pending.

### Trademarks and Product Names for SolidWorks Products and Services

SolidWorks, 3D PartStream.NET, 3D ContentCentral, eDrawings, and the eDrawings logo are registered trademarks and FeatureManager is a jointly owned registered trademark of DS SolidWorks.

CircuitWorks, Feature Palette, FloXpress, PhotoWorks, TolAnalyst, and XchangeWorks are trademarks of DS SolidWorks.

FeatureWorks is a registered trademark of Geometric Software Solutions Ltd.

SolidWorks 2011, SolidWorks Enterprise PDM, SolidWorks Simulation, SolidWorks Flow Simulation, and eDrawings Professional are product names of DS SolidWorks.

Other brand or product names are trademarks or registered trademarks of their respective holders.

### COMMERCIAL COMPUTER SOFTWARE - PROPRIETARY

U.S. Government Restricted Rights. Use, duplication, or disclosure by the government is subject to restrictions as set forth in FAR 52.227-19 (Commercial Computer Software - Restricted Rights), DFARS 227.7202 (Commercial Computer Software and Commercial Computer Software Documentation), and in the license agreement, as applicable.

Contractor/Manufacturer:

Dassault Systèmes SolidWorks Corporation, 300 Baker Avenue, Concord, Massachusetts 01742 USA

### Copyright Notices for SolidWorks Standard, Premium, Professional, and Education Products

Portions of this software © 1986-2010 Siemens Product Lifecycle Management Software Inc. All rights reserved.

Portions of this software © 1986-2010 Siemens Industry Software Limited. All rights reserved.

Portions of this software © 1998-2010 Geometric Ltd.

Portions of this software © 1996-2010 Microsoft Corporation. All rights reserved.

Portions of this software incorporate PhysX™ by NVIDIA 2006-2010.

Portions of this software © 2001 - 2010 Luxology, Inc. All rights reserved, Patents Pending.

Portions of this software © 2007 - 2010 DriveWorks Ltd.

Copyright 1984-2010 Adobe Systems Inc. and its licensors. All rights reserved. Protected by U.S. Patents 5,929,866; 5,943,063; 6,289,364; 6,563,502; 6,639,593; 6,754,382; Patents Pending.

Adobe, the Adobe logo, Acrobat, the Adobe PDF logo, Distiller and Reader are registered trademarks or trademarks of Adobe Systems Inc. in the U.S. and other countries.

For more copyright information, in SolidWorks see Help > About SolidWorks.

### Copyright Notices for SolidWorks Simulation Products

Portions of this software © 2008 Solversoft Corporation.

PCGLSS © 1992-2007 Computational Applications and System Integration, Inc. All rights reserved.

### Copyright Notices for Enterprise PDM Product

Outside In® Viewer Technology, © Copyright 1992-2010, Oracle

© Copyright 1995-2010, Oracle. All rights reserved.

Portions of this software © 1996-2010 Microsoft Corporation. All rights reserved.

### Copyright Notices for eDrawings Products

Portions of this software © 2000-2010 Tech Soft 3D.

Portions of this software © 1995-1998 Jean-Loup Gailly and Mark Adler.

Portions of this software © 1998-2001 3Dconnexion.

Portions of this software © 1998-2010 Open Design Alliance. All rights reserved.

Portions of this software © 1995-2009 Spatial Corporation.

This software is based in part on the work of the Independent JPEG Group

## Introduction

---

### To the Instructor

---

This document introduces SolidWorks users to the SolidWorks Motion Simulation rigid body kinematics and dynamics software package. The specific goals of this lesson are to:

- 1 introduce the basic concepts of rigid body kinematics and dynamic analyses and their benefits
- 2 demonstrate the ease of use and the concise process for performing these analyses
- 3 introduce the basic rules for rigid body kinematics and dynamic analyses.

This document is structured similar to lessons in the SolidWorks Instructor Guide. This lesson has corresponding pages in the *SolidWorks Motion Simulation Student Workbook*.

---

**Note:** This lesson does not attempt to teach all capabilities of SolidWorks Motion Simulation. It only intends to introduce the basic concepts and rules of performing rigid body kinematics and dynamic analyses and to show the ease of use and the concise process of doing so.

---

### Education Edition Curriculum and Courseware DVD

---

An *Education Edition Curriculum and Courseware DVD* is provided with this course.

Installing the DVD creates a folder named `SolidWorks Curriculum_and_Courseware_2011`. This folder contains directories for this course and several others.

Course material for the students can also be downloaded from within SolidWorks. Click the SolidWorks Resources tab in the Task Pane and then select Student Curriculum.

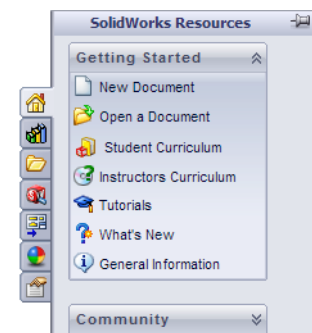

Double-click the course you would like to download. Control-select the course to download a ZIP file. The Lessons file contains the parts needed to complete the lessons. The Student Guide contains the PDF file of the course.

Course material for teachers can also be downloaded from the SolidWorks web site. Click the SolidWorks Resources tab in the Task Pane and then select Instructors Curriculum. This will take you to the Educator Resources page shown below.

Home > Support > Learning Resources > Educator Resources\*

### Educator Resources\*

Educator references including lesson plans, PowerPoint presentations, student goals, vocabulary, and student assessments. These materials are provided in a combination of project-based and topic-based formats.

**Note:** These Educator Resources are for SolidWorks 2010. For SolidWorks 2009 resources, [click here](#).

**EDU Curriculum Introduction (2010)**  
Overview of the guides and resources listed below.

Description	Type	ENG	FRA	DEU	ITA	ESP	JPN	CHS	CHT	PTB	SVE	KOR
Curriculum introduction		X	-	-	-	-	-	-	-	-	-	-
Resources		X	-	-	-	-	-	-	-	-	-	-

**SolidWorks Teacher Guide (2010)**  
Includes lesson plans, presentations, student goals, vocabulary, and assessments.

Description	Type	ENG	FRA	DEU	ITA	NOR	ESP	JPN	CHS	CHT	PTB	SVE	KOR
Student workbook		X	X	X	X	X	X	X	X	X	X	X	X
Student SolidWorks files		X	-	-	-	-	-	-	-	-	-	-	-
Teacher SolidWorks files		X	-	-	-	-	-	-	-	-	-	-	-
Instructor guide		X	X	X	X	X	X	X	X	X	X	X	X
Instructor Presentation		X	X	X	X	X	X	X	X	X	X	X	X

**Sustainability Project (2010)**  
Perform life cycle assessment.

Description	Type	ENG	FRA	DEU	ITA	ESP	JPN	CHS	CHT	PTB	SVE	KOR
Project workbook		X	X	X	X	X	X	X	X	-	-	-
SolidWorks files		X	-	-	-	-	-	-	-	-	-	-
Presentation		X	X	X	X	X	X	X	X	-	X	-

**SolidWorks@ Simulation Educator Guide (2010)**  
An introduction to the principles of analysis using SolidWorks Simulation.

Description	Type	ENG	FRA	DEU	ITA	ESP	JPN	CHS	CHT	PTB	SVE	KOR
Student workbook		X	X	X	X	X	X	X	X	X	-	-
Examples		X	-	-	-	-	-	-	-	-	-	-
Instructor guide		X	X	X	X	X	X	X	X	X	-	-

**SolidWorks@ Flow Simulation Educator Guide (2010)**  
An introduction to the principles of fluid flow analysis using Solidworks Flow Simulation.

Description	Type	ENG	FRA	DEU	ITA	ESP	JPN	CHS	CHT	PTB	SVE	KOR
Student workbook		X	-	-	-	-	X	-	-	-	-	-
Presentation		X	-	-	-	-	X	-	-	-	-	-
Instructor guide		X	-	-	-	-	X	-	-	-	-	-
Lesson files		X	-	-	-	-	-	-	-	-	-	-

**SolidWorks@ Motion Educator Guide (2010)**  
From dynamics to kinematics, incorporate theory through virtual simulation.

Description	Type	ENG	FRA	DEU	ITA	ESP	JPN	CHS	CHT	PTB	SVE	KOR
Student workbook		X	X	X	X	X	X	X	X	X	-	-
Examples		X	-	-	-	-	-	-	-	-	-	-
Instructor guide		X	X	X	X	X	X	X	X	-	X	-

**SAE Car Project (2010)**  
Design and Analyze Parts and Assemblies for Racing Competitions.

Description	Type	ENG	FRA	DEU	ITA	ESP	JPN	CHS	CHT	PTB	SVE	KOR
Project workbook		X	-	-	-	-	-	-	-	-	-	-
Student files		X	-	-	-	-	-	-	-	-	-	-
Instructor files		X	-	-	-	-	-	-	-	-	-	-

**Bridge Design Project (2010)**  
Use SolidWorks Simulation to analyze different loading conditions of the bridge.

Description	Type	ENG	FRA	DEU	ITA	ESP	JPN	CHS	CHT	PTB	SVE	KOR
Project workbook		X	X	X	-	X	X	X	-	-	-	-
Student files		X	-	-	-	-	-	-	-	-	-	-
Instructor files		X	-	-	-	-	-	-	-	-	-	-
Presentation		X	X	X	-	X	X	X	-	-	-	-

**CO2 Car Design Project (2010)**  
Design and analyze a CO2 powered car. Make design changes to reduce drag.

Description	Type	ENG	FRA	DEU	ITA	ESP	JPN	CHS	CHT	PTB	SVE	KOR
Project workbook and SolidWorks files		X	-	-	-	-	-	-	-	-	-	-
SolidWorks files		X	-	-	-	-	-	-	-	-	-	-

## SolidWorks Simulation Product Line

While this course focuses on the introduction to the rigid body dynamics using SolidWorks Motion Simulation, the full product line covers a wide range of analysis areas to consider. The paragraphs below lists the full offering of the SolidWorks Simulation packages and modules.

Static studies provide tools for the linear stress analysis of parts and assemblies loaded by static loads. Typical questions that will be answered using this study type are:

Will my part break under normal operating loads?

Is the model over-designed?

Can my design be modified to increase the safety factor?

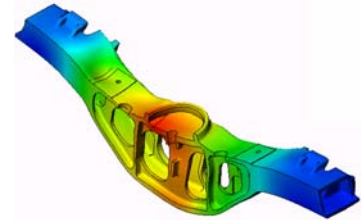

Buckling studies analyze performance of the thin parts loaded in compression. Typical questions that will be answered using this study type are:

Legs of my vessel are strong enough not to fail in yielding; but are they strong enough not to collapse due to loss of stability?

Can my design be modified to ensure stability of the thin components in my assembly?

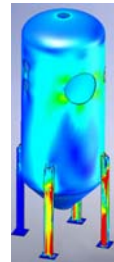

Frequency studies offer tools for the analysis of the natural modes and frequencies. This is essential in the design of many components loaded in both static and dynamic ways. Typical questions that will be answered using this study type are:

Will my part resonate under normal operating loads?

Are the frequency characteristics of my components suitable for the given application?

Can my design be modified to improve the frequency characteristics?

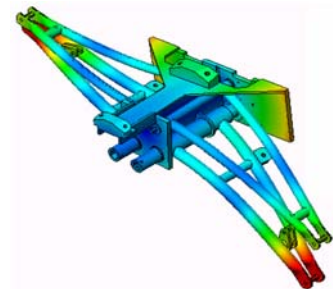

Thermal studies offer tools for the analysis of the heat transfer by means of conduction, convection, and radiation. Typical questions that will be answered using this study type are:

Will the temperatures changes effect my model?

How does my model operate in an environment with temperature fluctuation?

How long does it take for my model to cool down or overheat?

Does temperature change cause my model to expand?

Will the stresses caused by the temperature change cause my product failure (static studies, coupled with thermal studies would be used to answer this question)?

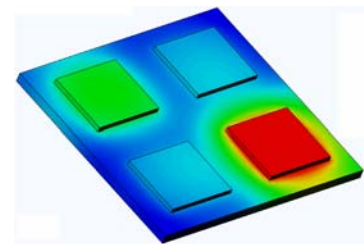

Drop test studies are used to analyze the stress of moving parts or assemblies impacting an obstacle. Typical questions that will be answered using this study type are:

What will happen if my product is mishandled during transportation or dropped?

How does my product behave when dropped on hard wood floor, carpet or concrete?

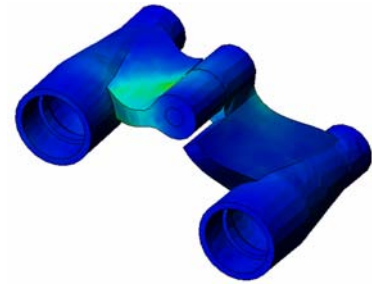

Optimization studies are applied to improve (optimize) your initial design based on a set of selected criteria such as maximum stress, weight, optimum frequency, etc. Typical questions that will be answered using this study type are:

Can the shape of my model be changed while maintaining the design intent?

Can my design be made lighter, smaller, cheaper without compromising strength of performance?

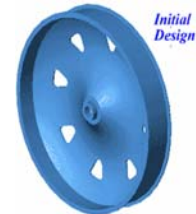

Fatigue studies analyze the resistance of parts and assemblies loaded repetitively over long periods of time. Typical questions that will be answered using this study type are:

Can the life span of my product be estimated accurately?

Will modifying my current design help extend the product life?

Is my model safe when exposed to fluctuating force or temperature loads over long periods of time?

Will redesigning my model help minimize damage caused by fluctuating forces or temperature?

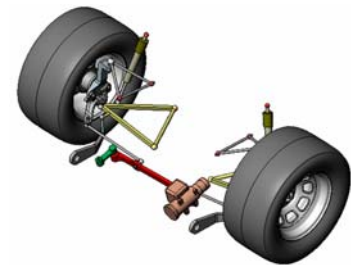

Nonlinear studies provide tools for analyzing stress in parts and assemblies that experience severe loadings and/or large deformations.

Typical questions that will be answered using this study type are:

Will parts made of rubber (o-rings for example) or foam perform well under given load?

Does my model experience excessive bending during normal operating conditions?



Dynamics studies analyze objects forced by loads that vary in time. Typical examples could be shock loads of components mounted in vehicles, turbines loaded by oscillatory forces, aircraft components loaded in random fashion, etc. Both linear (small structural deformations, basic material models) and nonlinear (large structural deformations, severe loadings and advanced materials) are available.

Typical questions that will be answered using this study type are:

Are my mounts loaded by shock loading when vehicle hits a large pothole on the road designed safely? How much does it deform under such circumstances?

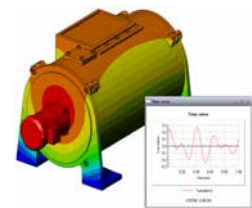

Flow Simulation enables user to analyze the behavior and effect of moving fluids around or within parts and assemblies. Heat transfer in both fluids and solids is considered as well. Pressure and temperature effect can subsequently be transferred into SolidWorks Simulation studies to continue with the stress analysis. Typical questions that will be answered using this modulus are:

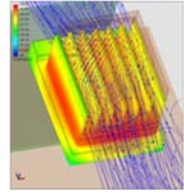

Is the fluid moving too fast and will it cause problems in my design?  
Is the moving fluid too hot or too cold?  
Is the heat transfer in my product efficient? Can it be improved?  
How effective is my design at moving fluid through the system?

Composites modulus allows users to simulate structures manufactured from laminated composite materials.

Typical questions that will be answered using this modulus are:

Is the composite model failing under the given loading?  
Can the structure be made lighter using composite materials while not compromising with the strength and safety?  
Will my layered composite delaminate?



## Basic Functionality of SolidWorks Motion

### Goals of This Lesson

---

Introduce kinematics and dynamic analysis as a tool to complement 3D modeling using SolidWorks. Upon successful completion, the students should be able to understand the basic concepts of mechanism behavior and how SolidWorks Motion can help them determine important design parameters like Velocities, Accelerations, Forces and Moments etc. Students will be able to see the combined power of 3D modeling and mechanism analysis in the design process.s

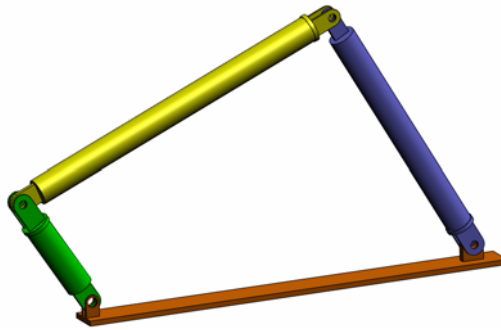

Introduce mechanism analysis using an active learning exercise. The active learning exercise in this lesson is designed to break the ice by having the students go through few steps to complete the exercise. With this concept in mind, the steps are performed with minimal description.

Show the students a proper way of correctly simulating their mechanisms using SolidWorks Motion.



## Outline

---

- In Class Discussion
- Active Learning Exercise – Motion analysis of a 4 bar mechanism
  - Opening the 4Bar .SLDASM document
  - Checking the SolidWorks Motion menu
  - Model Description
  - Switching to SolidWorks Motion manager
  - Fixed and Moving Components
  - SolidWorks Assembly Mates driving the motion
  - Specifying the Input Motion
  - Running the Simulation
  - Looking at the results
  - Creating a Trace Path
- 5 Minute Assessment
- In Class Discussion – Calculating the torque required to generate the motion
- More to Explore – Modifying the Geometry
- Exercises and Projects – Studying
- Lesson Summary

## In Class Discussion

---

Ask the students to identify mechanisms around them and how they behave. Ask them how Motion simulation software can be beneficial for an engineer. They can explain with respect to the 4Bar linkage.

### Answer

Motion simulation software can be used to study the displacement, velocity, acceleration acting on the moving components. For example by simulating a 4Bar linkage the student can study these parameters on each link.

In addition Motion simulation software also gives the reaction forces/moments acting on each mate. This information can be used by an engineer to get an idea on how much torque is required to drive the 4Bar mechanism.

The reaction and the body forces acting on each component can be exported to SolidWorks Simulation stress analysis to study their effects (deformation and stress) on the component.

Motion simulation software can help design springs, dampers and cams needed for the functioning of your mechanism. It can also aid in sizing of motors and actuators needed to drive the motion of mechanisms.

### More to explore

Regarding the structural analysis, ask the students how the forces acting on a particular object (whose stress is analyzed within SolidWorks Simulation) were determined. Are these forces always known or estimated from known formulas?

### Answer

In some problems involving mechanisms these loads are either known or can be neglected. For example in a 4 bar linkage mechanism if the angular velocity of rotation is small then the body forces acting on the links are small and can be neglected. But for mechanism operating at high speeds like the cylinder and piston of an engine, the forces can be large and cannot be neglected. To determine these forces one can use SolidWorks Motion simulation and then export these forces to a SolidWorks Simulation stress analysis to study the structural integrity of the components.

## Active Learning Exercise – Motion analysis of a 4 bar mechanism

---

Use SolidWorks Motion Simulation to perform motion analysis on the 4Bar .SLDASM assembly shown below. The green link is given an angular displacement of 45 degrees in 1 sec in the clockwise direction and it is required to determine the angular velocity and acceleration of the other links as a function of time. Also we will calculate the torque needed to induce this motion as an in class discussion topic.

The step by step instructions are given below.

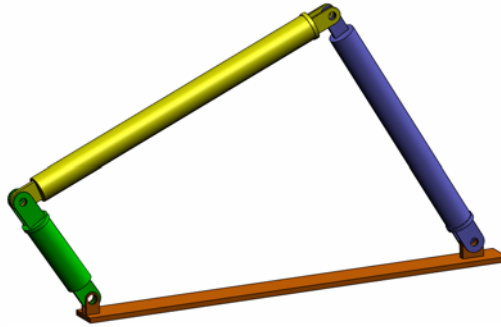

### Opening the 4Bar.SLDASM document

- 1 Click **File, Open**. In the Open dialog box, browse to the 4Bar .SLDASM assembly located in the corresponding subfolder of the SolidWorks Curriculum\_and\_Courseware\_2011 folder and click **Open** (or double-click the part).

### Checking the SolidWorks Motion Add-In

Make sure that SolidWorks Motion Add-In is activated.

To do so:

- 1 Click **Tools, Add-Ins**. The **Add-Ins** dialog box appears.
- 2 Make sure that the check boxes next to SolidWorks Motion are checked.
- 3 Click **OK**.

## Model Description

This model represents a typical 4 bar linkage mechanism. The Base part is fixed and cannot move. It always stays horizontal and in real life is fixed to the ground. The other three links are connected to each other and to the base with pins. The links are allowed to hinge about the pins in the same plane and any out of plane motion is prevented. When you model this mechanism in SolidWorks we create mates to put the parts in place. SolidWorks Motion automatically translates these mates into the internal joints. Each mate has several degrees of freedom associated with it. For example a concentric mate has only two degrees of freedom (translation and rotation about its axis). For more details on mates and the degrees of freedom they have please refer to the online help on SolidWorks Motion Simulation.

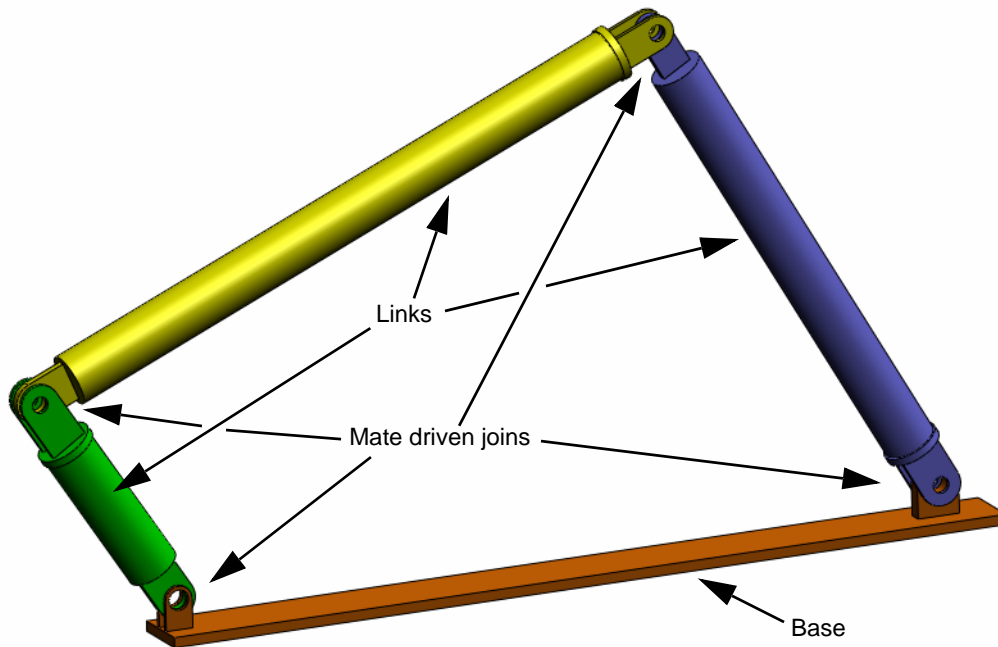

## Switching to SolidWorks Motion Manager

Switch to SolidWorks Motion by clicking the Animation1 tab in the bottom left hand corner.

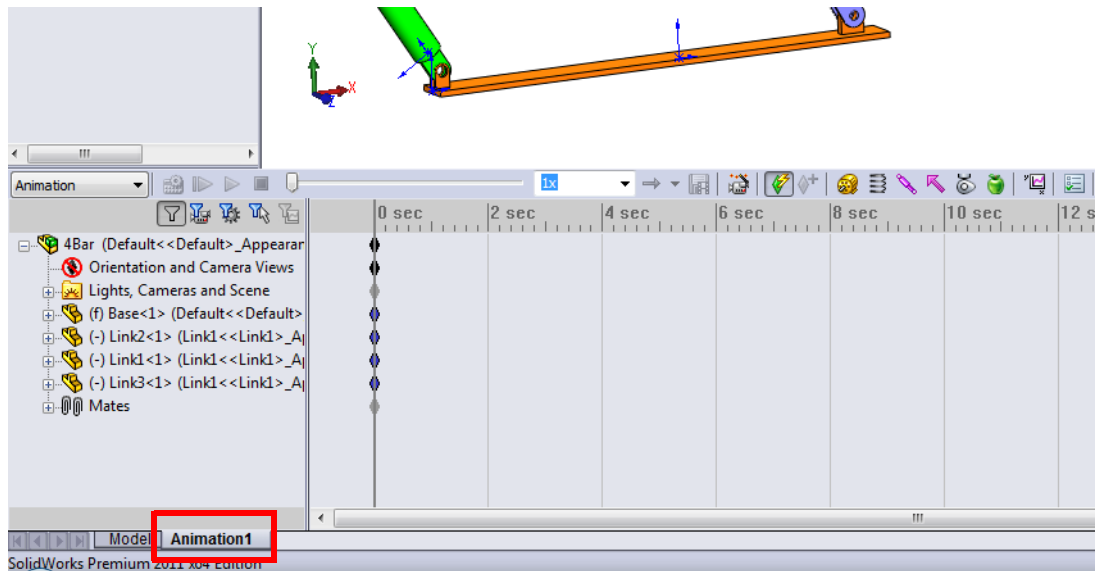

SolidWorks Motion takes full advantage of SolidWorks Animator and thus the look and feel of the SolidWorksMotionManager is very similar to that of the SolidWorks Animator.

## Fixed and Moving Components

Fixed and moving components in SolidWorks Motion are determined by their **Fix/Float** status in the SolidWorks model. In our case, Base component is fixed while the other three links are moving.

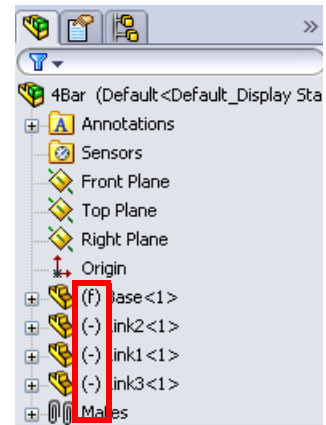

## Automatic Creation of internal joints from SolidWorks Assembly Mates

The motion of the mechanism is fully defined by the SolidWorks mates.

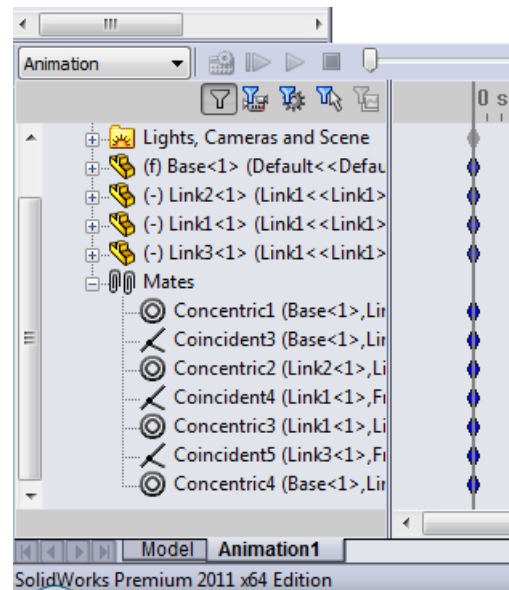

## Specifying the Input Motion

Next we will define a motion to one of the links. In this example we would like to rotate Link2 by 45 degrees clockwise about the Base. To do this we will impose a rotary motion to Link2 at the location of the concentric mate simulating the pin connection with the Base. The angular displacement needs to be achieved in 1 sec and we will use a step function to ensure that Link2 rotates smoothly from 0 to 45 degrees.

Click on the **Motor** icon  to open the **Motor** dialog.

Under **Motor Type** select **Rotary Motor**.

Under **Component/Direction**, select the cylindrical face of Link2 pinned to the Base (see the figure) for both the **Motor Direction** and **Motor Location** fields. The motor will be located at the center of the selected cylindrical face.

Under **Motion** select **Expression** to open the **Function Builder** window.

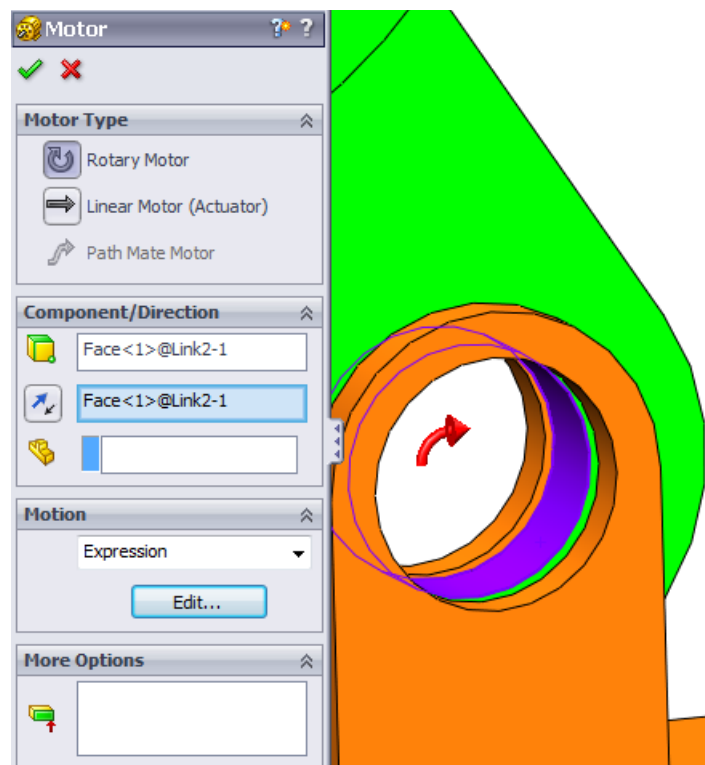

**Note:** The last field under **Component/Direction** property dialog, **Component to more relative to**, is used to specify reference component for the relative motion input. Since we wish to move Link2 with respect to the fixed Base, this field will be left blank.

The last property dialog, **More Options**, enables user to specify the Load-bearing faces/Edges for the transfer of the motion loads in the SolidWorks Simulation stress analysis software.

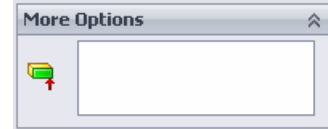

In the **Function Builder** window, select **Displacement (deg)** for **Value (y)** and enter **STEP(TIME,0,0D,1,45D)** in the **Expression Definition** field.

**Note:** You can also double-click **STEP(x,h0,x1,h1)** from the list of the available functions on the right hand side of the **Function Builder** window.

The Function Builder window displays the following configuration:

- Value (y):** Displacement (deg)
- Expression Definition:** STEP(TIME,0,0D,1,45D)
- Mathematical Functions:**

Function	Description
SIGN(a1,a2)	Transfers the sign of a2 to the magnitude of a1
SIN(a)	Sine of expression a.
SINH(a)	Hyperbolic sine of expression a.
SQRT(a)	Square root of expression a.
STEP(x,x0,h0,x1,h1)	Represents cubic polynomial transition from h0 to h1
STEP5(x,x0,h0,x1,h1)	Represents quintic polynomial transition from h0 to h1
SWEEP(x,a,x0,f0,x1,f1,dx)	Constant amplitude sinusoidal with linearly increasing phase
TAN(a)	Tangent of expression a.
TANH(a)	Hyperbolic tangent of expression a.
- Show graphs:** Displacement, Velocity, Acceleration, Jerk (all checked)
- Minimum x value:** 0
- Maximum x value:** 5
- Name:** User function 1

The graphs on the bottom of the **Function Builder** window will show the variations of the displacements, velocities, accelerations and jerk

Click **OK** twice to close the **Function Builder** window and the **Motor PropertyManager**.

## Motion analysis type

SolidWorks offers three types of the assembly motion simulation:

- 1 **Animation** is simple motion simulation ignoring the components' inertial properties, contacts, forces and similar. Its use is suited for the verification of the correct mates or basic animations, for example.
- 2 **Basic Motion** offers some level of realism by accounting for the inertial properties of the components for example. It does not, however, recognize externally applied forces.
- 3 **Motion Analysis** is the most sophisticated motion analysis tool reflecting all required analysis features such as inertial properties, external forces, contacts, mate friction etc.

Under **Type of Study** on the left hand side of the SolidWorksMotionManager, select **Motion Analysis**.

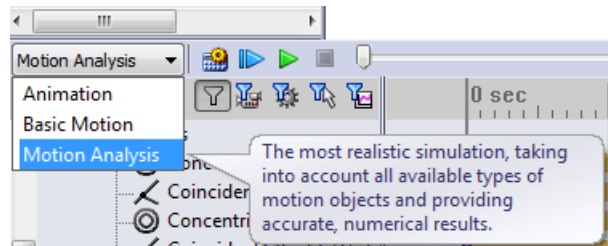

## Simulation time

The duration of the motion simulation is driven by the topmost time line in the SolidWorksMotionManager. Because SolidWorks Motion sets the default analysis duration to 5 seconds this parameter needs to be modified.

Move the end time key of the topmost timeline from 5 second to a 1 second location.

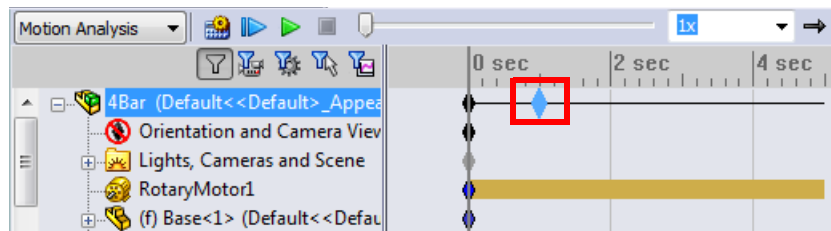



---

**Note:** The zoom keys  allow you to zoom in and out on the time line.

Right-clicking on the timeline key allows you to manually input the desired simulation time.

---

## Running the Simulation

In the SolidWorksMotionManager click the **Calculate** icon .

Note the motion simulation during the calculation.

## Looking at the Results

### Absolute results in the global coordinate system

First let us plot the angular velocity and acceleration for Link1.

Click the **Results and Plots** icon  to open the **Results** dialog.



Under **Results** select **Displacement/Velocity/Acceleration, Angular Velocity** and **Z Component**.

Still under **Results** select Link1.

The **Component to define XYZ directions (optional)** field is used to reference our plot results with respect to a local coordinate system of another moving component. To plot the results in the default coordinate system shown in the figure, leave this field empty.

Click **OK** to show the plot.

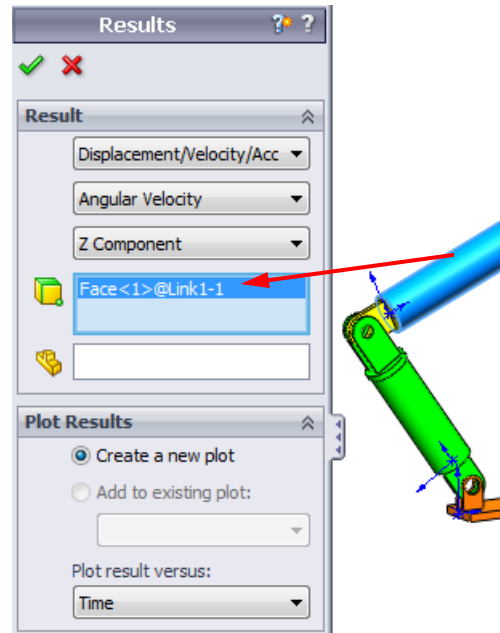

The plot shows the variation of the angular velocity of the center of mass for Link1 as function of time.

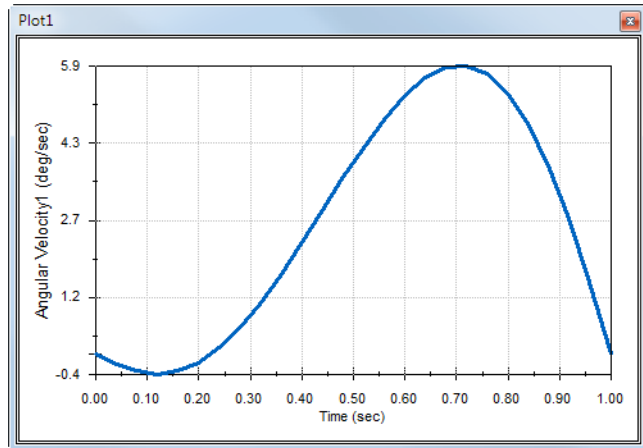

Repeat the above procedure to plot the **Z Component** of the **Angular Acceleration** for the center of mass of Link1.

In the global coordinate system, the results indicate the maximum angular velocity and angular acceleration of 6 deg/sec and 38 deg/sec<sup>2</sup>, respectively.

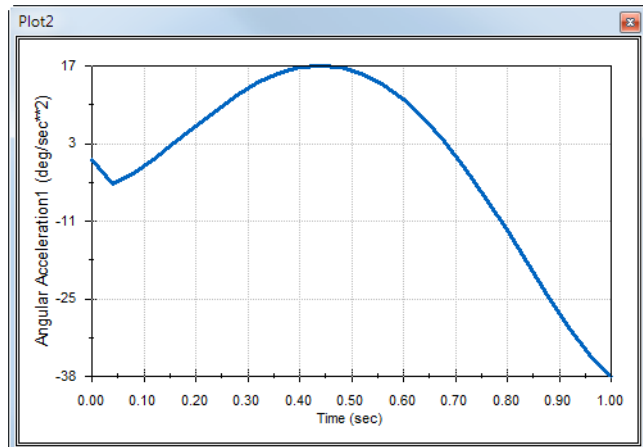

Similarly, create the plots of the **Z Component** of angular velocity and angular acceleration at the center of mass for Link2 and Link3.

## Storing and editing result plots

The generated result plot features are stored in the newly created **Results** folder on the bottom of the SolidWorksMotionManager.

Right-clicking on any plot feature allows you to hide and show the plot, as well as edit its settings.

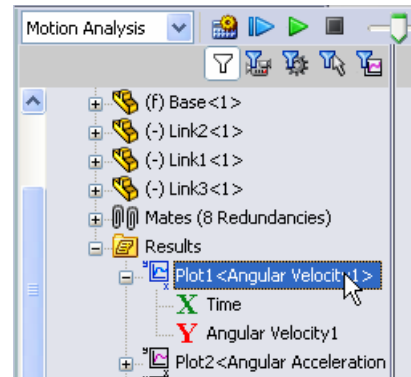

## More on the Results

### Relative results in global coordinate system

Let us plot the **Z Component** of the relative angular acceleration of Link1 with respect to Link3.

Expand the **Results** folder. Make sure that **Plot2** is shown. Right-click on **Plot2** and select **Edit Feature**.

Select Link3 as the second component in the **Select one or two part faces or one mate/simulation element to create results** field.

Click **OK** to show the plot.

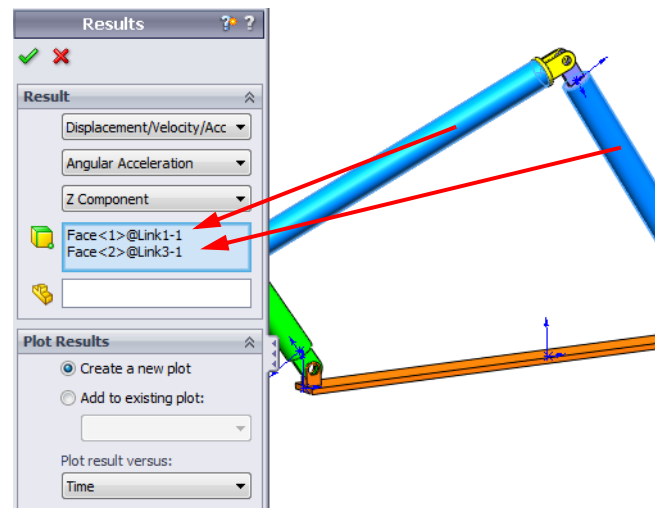

The plot shows the acceleration magnitude of Link1 (its center of mass) with respect to Link3 (part's coordinate system). The maximum relative acceleration is  $139 \text{ deg/sec}^2$  in the negative rotational Z direction.

Note also that the variation of the acceleration changed significantly when compared to the absolute acceleration result for Link1 alone above.

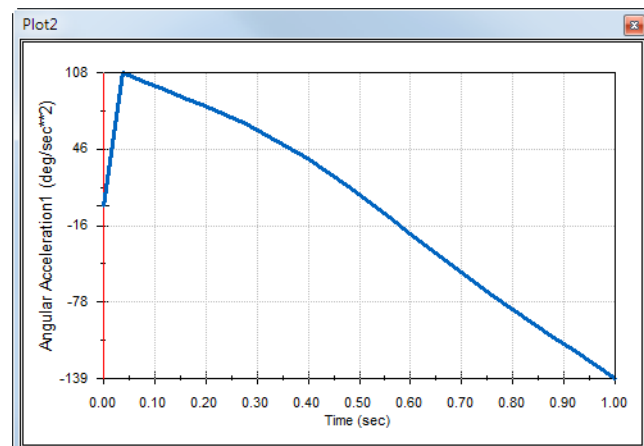

**Note:** The positive rotational direction can be determined using the right hand rule. Point the thumb of the right hand into the direction of the axis (in our case it would be the Z axis). Your fingers will then show the positive direction for the Z component of the rotation.

### Relative results in local coordinate system

Let us transform the Z component of the absolute acceleration of Link1 into the local coordinate system of Link2.

Edit the above plot, Plot2, delete Link3 from the **Select one or two part faces or one mate/simulation element to create results** field.

Then select Link2 in the **Component to define XYZ directions** field.

Click **OK** to show the plot.

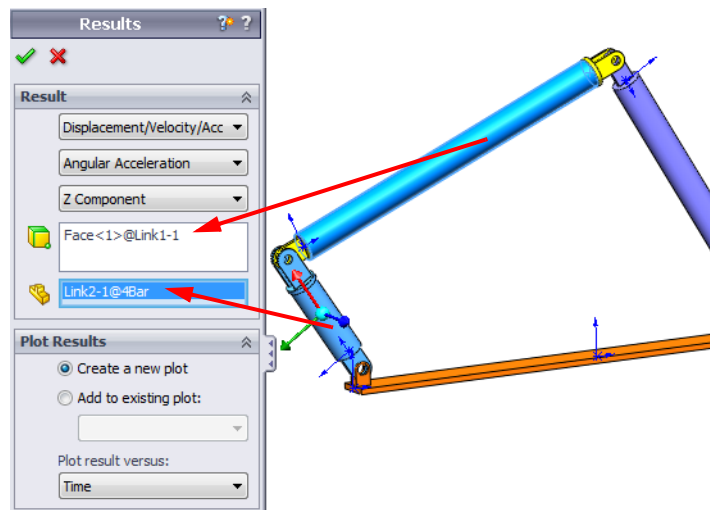

**Note:** The triad on the Link2 component indicates the output local coordinate system. Contrary to the global coordinate system which is fixed, local coordinate systems may rotate. In our case, the selected local coordinate system will rotate because Link2 component rotates as the mechanism moves.

The maximum Z component of absolute acceleration of Link1 in the local coordinate system of Link2 is 38 deg/sec<sup>2</sup> in the negative Z rotational direction.

Comparing this absolute result in the local coordinate system to the absolute acceleration in the global coordinate system, we conclude that they are identical. This is because Z axes in both systems are aligned.

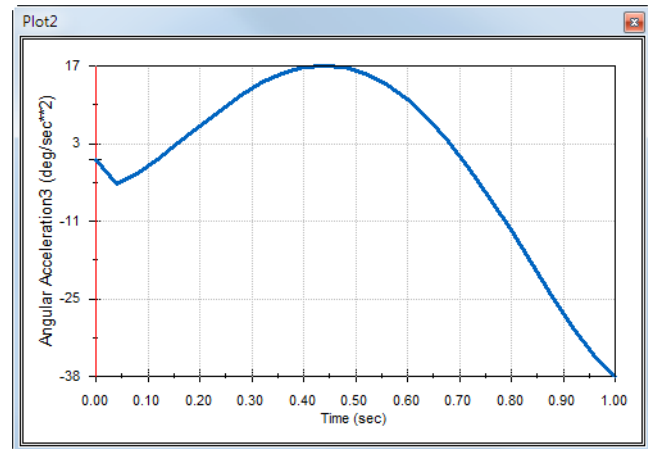

Repeat the above for various selection of components and local coordinate systems.

### Create a Trace Path

SolidWorks Motion allows you to graphically display the path that any point on any moving part follows. This is called a trace path. You can create trace path with reference to any fixed part or with reference to any moving component in the assembly. We will create a trace path for a point located on Link1 component.

To create a trace path right click on the **Results and Plots** icon.

In the **Results** dialog select **Displacement/Velocity/Acceleration** and **Trace Path**.

In the first selection field select the circular edge on **Link1** to identify the center point of the circle. The sphere graphically shows the center of the circle.

Check the **Show vector in graphics window** check box.

The path will then show on the screen as black curve.

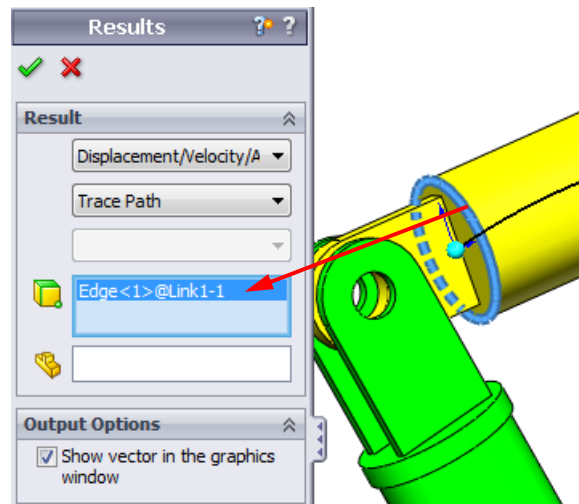



---

**Note:** The resulting trace path is by default shown with respect to the fixed ground. To show the trace path with respect to another moving component, one would have to select this reference component as a second item in the same selection field.

---

Click **OK** to close the **Results** dialog.

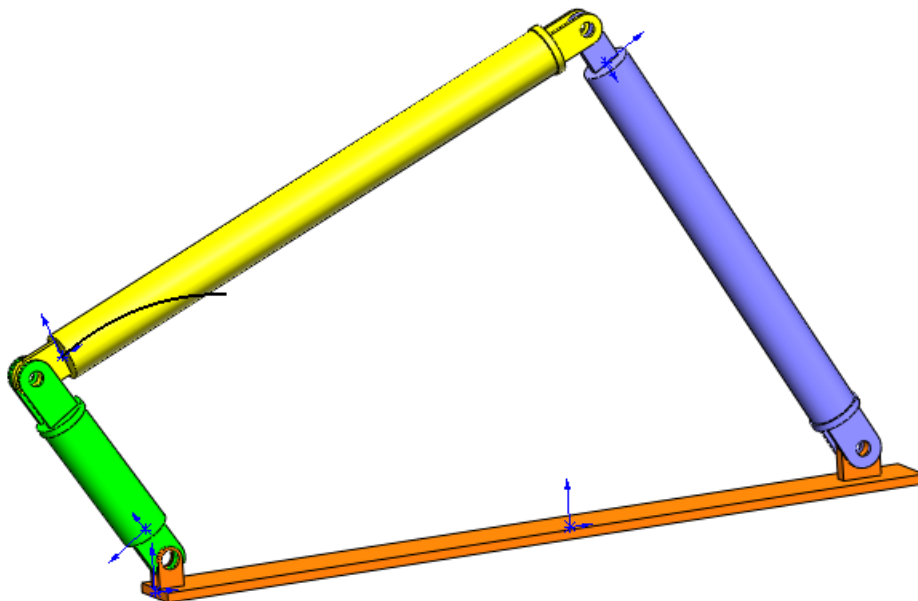
Zoom out to see the entire model and **Play** the simulation.



This completes your first SolidWorks Motion simulation.

## 5 Minute Assessment – Answer Key

---

1. How do you start a SolidWorks Motion session?

**Answer:** On the Windows task bar, click **Start, Programs, SolidWorks, SolidWorks Application**. The SolidWorks application starts. Click the SolidWorks Motion Manager tab (by default named `Animation1`) on the bottom of the SolidWorks document window.

2. How do you activate SolidWorks Motion Add-In?

**Answer:** Click **Tools, Add-Ins**, check **SolidWorks Motion** to select it, and click **OK**.

3. What types of motion simulations are available in SolidWorks?

**Answer:** SolidWorks features three types of the motions simulations: Animation, Basic Motion, Motion Analysis.

4. What is analysis?

**Answer:** Analysis is a process to simulate how your design performs in the field.

5. Why analysis is important?

**Answer:** Analysis can help you design better, safer, and cheaper products. It saves you time and money by reducing traditional, expensive design cycles.

6. What does SolidWorks Motion analysis calculate?

**Answer:** Motion analysis calculates displacements, velocities, accelerations and reaction forces on your model when it moves.

7. Does SolidWorks Motion assume the parts to be rigid or flexible?

**Answer:** SolidWorks Motion does only rigid body analysis and hence assumes all parts to be perfectly rigid.

8. Why is motion analysis important?

**Answer:** Motion analysis can tell you how safe and economical your design is under its operating conditions.

9. What are the main steps in performing motion analysis?

**Answer:** The main steps are: creating the mechanism in SolidWorks (creating the mates), applying motion to the driving part, running the simulation and visualizing the results.

10. What is a trace path?

**Answer:** A trace path is a path or trajectory that any point on a moving part follows.

11. Are SolidWorks mates used in SolidWorks Motion model?

**Answer:** Yes. SolidWorks mates are used to automatically created internal joints in SolidWorks Motion. Mates therefore define the motion of the simulated mechanism.

## In Class Discussion – Calculating the Torque needed to drive the 4 bar mechanism

Ask the student how the angular motion was given to the driving link of the 4Bar mechanism. Often times such mechanisms are driven by motors. One important parameter in sizing the motor is the torque generated by the motor, which is one of the standard output quantities in SolidWorks Motion. Finding this torque will help us choose the right motor for the application.

How is the torque calculated from SolidWorks Motion?

### Answer

Click on the **Results and Plots** icon to open the **Results** dialog.

Specify **Forces**, **Motor Torque**, **Magnitude** and select the **RotaryMotor1** feature driving the mechanism (in this example we gave the Link2 an angular velocity of 45 degrees in 1 sec).

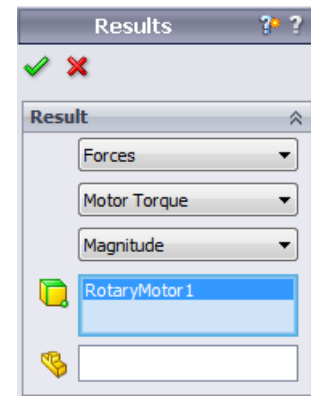

Click **OK** to generate the plot.

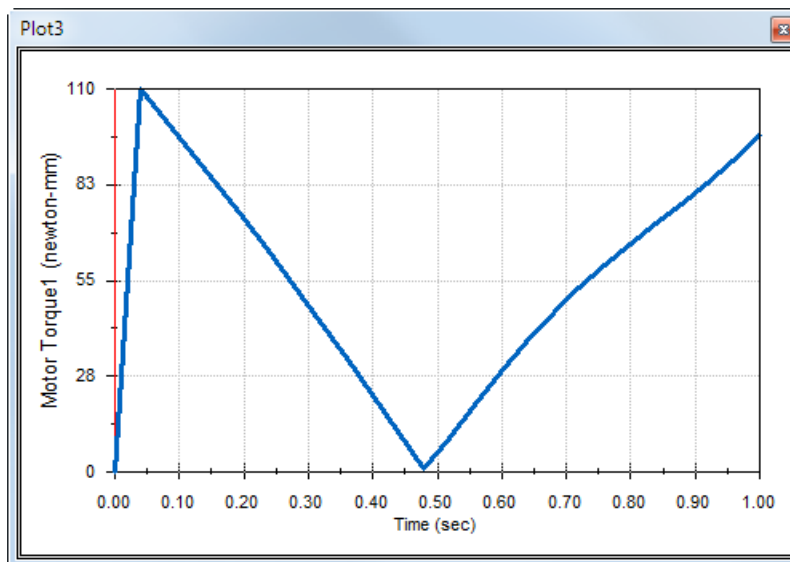

The required torque is about 110 N-mm

## More to Explore — Modifying the Geometry

Ask the students to modify the geometry of `Link3` so that the 4Bar mechanism looks like the one shown in the image below. Now ask them to use SolidWorks Motion to calculate the new torque required to drive this mechanism. Use the same uniform angular velocity input of 45 deg/sec. Will the new driving torque be higher or lower? Why?

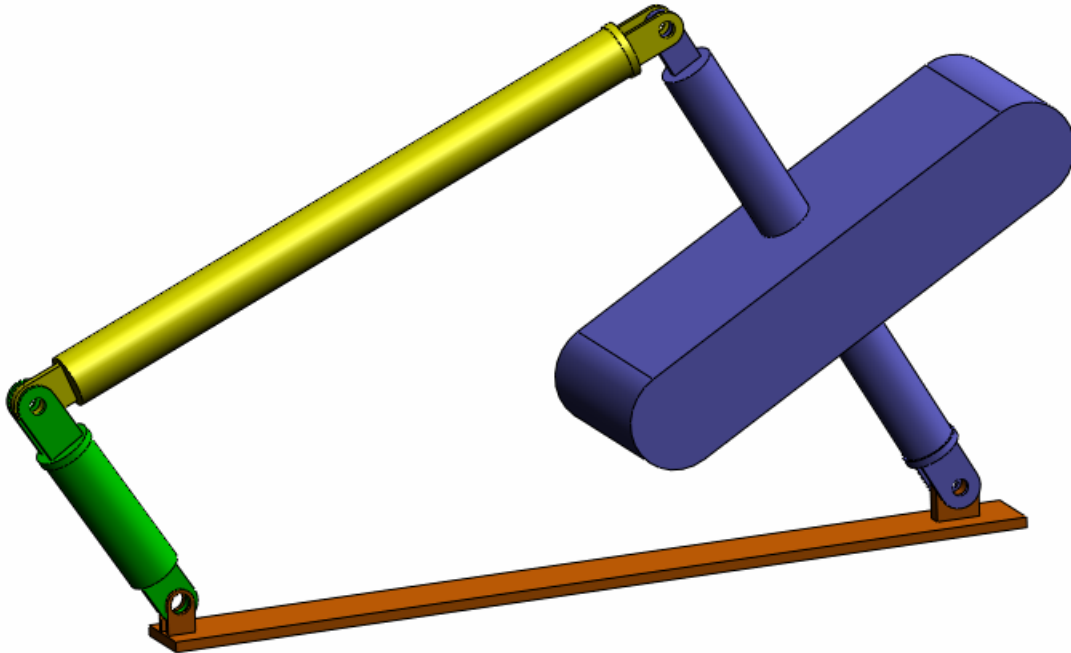

### Answer

- 1 Click the **Model** tab on the bottom of the SolidWorks document window.

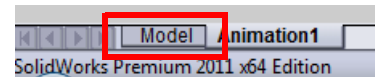

- 2 Open the part `Link3`.
- 3 **Unsuppress** the feature `Extrude5` from the SolidWorks feature tree.
- 4 Save the part `Link3` and close the part.
- 5 When you come to the assembly `4Bar` you will see the new and updated assembly. (Note that when prompted to update your assembly, select Yes)
- 6 Now go to SolidWorks Motion (in our case click the `Animation1` tab on the bottom of the SolidWorks document folder). Notice that all the mates are retained. Also make sure that the `Link2` angular motion is the same.
- 7 Click the **Calculate** icon.
- 8 Plot the torque and determine the new required magnitude.

The required driving torque is now higher because `Link3` is heavier; it takes more torque to drive the mechanism.

## Exercises and Projects — Slider Crank Mechanism

---

Now you will see how to use SolidWorks Motion to simulate a slider crank mechanism. The goal is to calculate the velocity and acceleration of the center of mass of the reciprocating part.

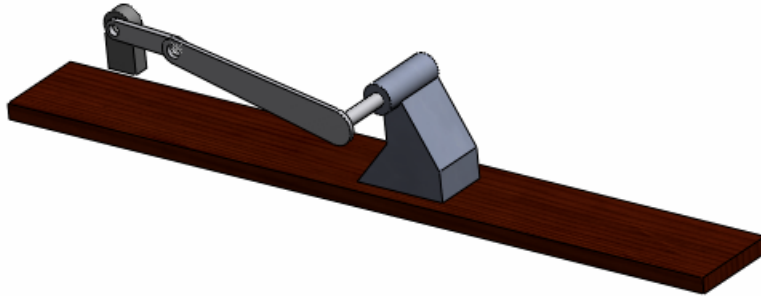

### Tasks

- 1 Open the SliderCrank.sldasm located in the corresponding subfolder of the SolidWorks Curriculum\_and\_Courseware\_2011 folder and click **Open** (or double-click the part).

This model represents a slider crank mechanism where a rotary motion of the crank is transformed into reciprocating translational motion of the slider. The crank is rotated with a uniform velocity of 360 degrees per second.

- 2 Review the fixed and moving parts in the assembly.

**Answer:** Parts fixed in SolidWorks are also treated as fixed in SolidWorks Motion. In our case the Ground and BasePart are fixed, the remaining components are moving.

- 3 Prescribe uniform **360 deg/sec** rotational velocity to the Crank. Make sure that the motion is specified at the BasePart/Crank pin location. (You can enter **360 deg/sec** directly into the **Motor speed** field. SolidWorks Motion then converts the value to RPM).

**Answer:** Do the following.

- Right-click on the **Motor** icon to open the **Motor** dialog.



- Under **Motor Type** select **Rotary Motor**.
- Under **Component/Direction** select the cylindrical face for both the **Motor Location** and **Motor Direction** fields, as shown in the figure.
- Under **Motion** select **Constant Speed** and enter **360 deg/sec**.
- Click **OK**.

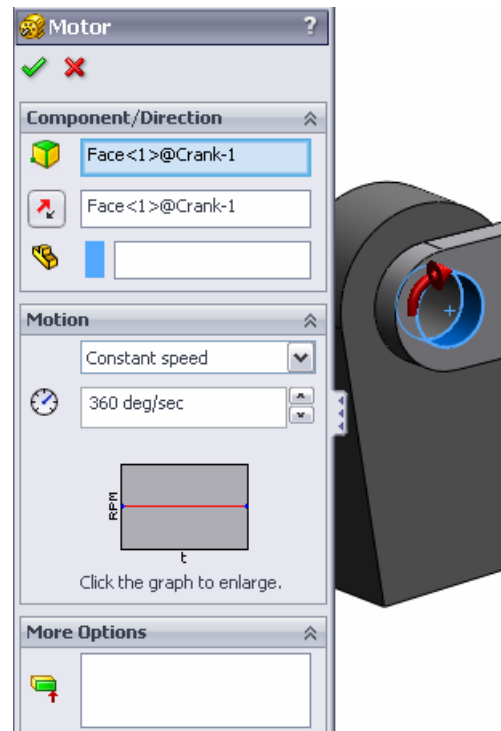

- 4 Run the simulation.

**Answer:** In SolidWorks MotionManager, click the **Calculate** icon. Make sure that the **Type of Study** field is set to **Motion Analysis**.

- 5 Determine the velocity and acceleration of the MovingPart.

**Answer:** Do the following:

- Click the **Results and Plots** icon to open the **Results** dialog.
- Select **Displacement/Velocity/Acceleration, Linear Velocity** and **X Component**.
- Select any face on the MovingPart.

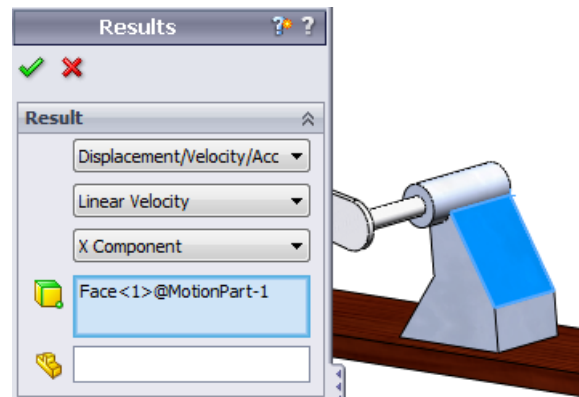

- Click **OK** to generate the plot.

Similarly generate plot for the X component of the acceleration.

## Lesson 1 Vocabulary Worksheet – Answer Key

---

Name \_\_\_\_\_ Class: \_\_\_\_\_ Date: \_\_\_\_\_

*Directions: Fill in the blanks with the proper words.*

1. The sequence of creating a model in SolidWorks, manufacturing a prototype, and testing it: **traditional design cycle**
2. The method used by SolidWorks Motion to perform motion analysis: **Rigid Body Kinematics and Dynamics**
3. The entity that connects two parts and also governs the relative motion between the two parts: **mates**
4. How many degrees of freedom does a free body have? : **A free body has 6 degrees of freedom (3 translations, 3 rotations)**
5. How many degrees of freedom does a concentric mate have? : **A concentric mate has 2 degree of freedom (rotation about its axis, translation along its axis)**
6. How many degrees of freedom does a fixed part have? : **Zero. A fixed part cannot translate or rotate in any direction**
7. A path or trajectory that any point on a moving part follows: **Trace path**
8. The trace path of a reciprocating cylinder with respect to the ground represents a: **Straight line**
9. The types of Motion that can be given to a concentric mate: **Angular and Translational Displacements, Velocities and Accelerations)**
10. In SolidWorks Motion the movement of gears can be simulated using: **Gear mates**
11. A mechanism that is used to transform rotary motion to reciprocating motion: **Rack and Pinion mate**
12. The ratio of the output torque exerted by the driven link to the necessary input torque required at the driver: **Mechanical Advantage**

## Lesson 1 Quiz — Answer Key

---

Name: \_\_\_\_\_ Class: \_\_\_\_\_ Date: \_\_\_\_\_

*Directions: Answer each question by writing the correct answer or answers in the space provided.*

1. How do switch between the SolidWorks Motion Manager and SolidWorks Feature Manager?

**Answer:** Click the Model or Animation1 tab in the lower left hand corner of the SolidWorks document folder.

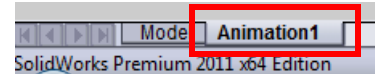

2. What types of motion analyses can you perform in SolidWorks Motion?

**Answer:** Rigid body kinematics and dynamic analysis

3. How does SolidWorks Motion automatically create internal joints?

**Answer:** SolidWorks Motion internal joints are automatically created from SolidWorks mates.

4. How do you assign motion to a part?

**Answer:** Right click on the **Motor** icon to open the **Motor** dialog. In the dialog box you can assign displacement, velocity and acceleration to the selected part.

5. If I want to assign a rotary motion to a part smoothly with a given time then how should I assign the motion?

**Answer:** The motion is assigned as a step function over the given time.

6. How many degrees of freedom does a point-to-point coincident mate have?

**Answer:** A point-to-point coincident mate has 3 degrees of freedom (rotation about X, Y and Z axes)

7. What is a trace path?

**Answer:** A path or trajectory that any point on the moving part follows.

8. Name one application of trace path?

**Answer:** Trace paths can be used to generate a CAM profile.

## Lesson Summary

---

- ❑ SolidWorks Motion is design analysis software (kinematics and dynamic) fully integrated in SolidWorks.
- ❑ Design analysis can help you design better, safer, and cheaper products.
- ❑ SolidWorks Motion assumes all the components to be rigid bodies.
- ❑ SolidWorks Motion automatically creates internal joints from SolidWorks mates.
- ❑ SolidWorks Motion can create trace path on any point in a moving body with respect to any other body in the assembly.
- ❑ The steps to perform analysis in SolidWorks Motion are:
  - Create the SolidWorks assembly
  - Fix the grounded part in the SolidWorks assembly.
  - Joints are automatically created from mates.
  - Apply motion to the parts.
  - Run the simulation.
  - Analyze the results.